

MINI-CRETA 3" ARCHITECTURAL

DESCRIPTION: Wall double-sided **TEXTURE:** Split face with straight edged corners

PALLET OVERVIEW

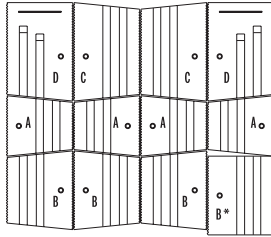

COMPATIBLE CAPS

See page 140 for product compatibility.



NOTES

When building a double-sided wall one pallet will cover an average of 21.76 ft².

B* unit can be used as a regular or vertical unit.

See page 135 to 156 for more technical information.

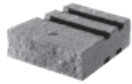
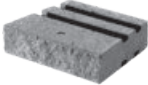
| Specifications per pallet | Imperial | Metric |
|---------------------------|--------------------------|---------------------|
| Cubing | 24 ft² | 2.23 m ² |
| | 95.01 lin. ft | 28.96 lin. m |
| Approx. Weight | 2 465 lbs | 1 118 kg |
| Minimum radius | 7 ft | 2.1 m |
| Number of rows | 8 | |
| Coverage per row | 3 ft ² | 0.28 m ² |
| Linear coverage per row | 11.88 lin. ft | 3.62 lin. m |

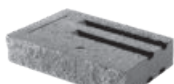
| | Unit dimensions | in | mm | Units/pallet | |
|---|---|----------|---------|--------------|---|
|  |  | Height | 2 15/16 | 75 | 32 units |
| | Depth | 9 13/16 | 250 | | |
| | Length 1 | 9 1/16 | 230 | | |
| | Length 2 | 7 1/16 | 180 | | |
| B |  | Height | 2 15/16 | 75 | 24 units |
| | Depth | 9 13/16 | 250 | | |
| | Length 1 | 11 13/16 | 300 | | |
| | Length 2 | 9 13/16 | 250 | | |
| B* |  | Height | 2 15/16 | 75 | 8 units |
| | Depth | 9 13/16 | 250 | | |
| | Length 1 | 11 13/16 | 300 | | |
| | Length 2 | 11 13/16 | 300 | | |
| C |  | Height | 2 15/16 | 75 | 16 units |
| | Depth | 9 13/16 | 250 | | |
| | Length 1 | 14 3/4 | 375 | | |
| | Length 2 | 12 13/16 | 325 | | |
| D |  | Height | 2 15/16 | 75 | 16 units 8 right corners 8 left corners |
| | Depth | 9 13/16 | 250 | | |
| | Length 1 | 14 3/4 | 375 | | |
| | Length 2 | 13 3/4 | 350 | | |

Chocolate Brown

Chestnut Brown

Sandlewood

Champlain Grey

Shale Grey

Onyx Black





MINI-CRETA 6" ARCHITECTURAL

DESCRIPTION: Wall double-sided **TEXTURE:** Split face with straight edged corners

PALLET OVERVIEW

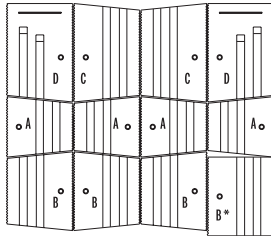

COMPATIBLE CAPS

See page 140 for product compatibility.





NOTES

When building a double-sided wall one pallet will cover an average of 27.21 ft².

B* unit can be used as a regular or vertical unit.

See page 135 to 156 for more technical information.

| Specifications per pallet | Imperial | Metric |
|---------------------------|--------------------------|---------------------|
| Cubing | 30 ft² | 2.79 m ² |
| | 59.38 lin. ft | 18.10 lin. m |
| Approx. Weight | 3 086lbs | 1 400 kg |
| Minimum radius | 7 ft | 2.1 m |
| Number of row | 5 | |
| Coverage per row | 6 ft ² | 0.56 m ² |
| Linear coverage per row | 11.88 lin. ft | 3.62 lin. m |

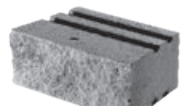
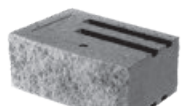
| | Unit dimensions | in | mm | Units/pallet | |
|---|---|----------------------------------|-------------------------------|--------------|---|
|  |  | Height | 5 ⁷ / ₈ | 150 | 20 units |
| | Depth | 9 ¹³ / ₁₆ | 250 | | |
| | Length 1 | 9 ¹ / ₁₆ | 230 | | |
| | Length 2 | 7 ¹ / ₁₆ | 180 | | |
| B |  | Height | 5 ⁷ / ₈ | 150 | 15 units |
| | Depth | 9 ¹³ / ₁₆ | 250 | | |
| | Length 1 | 11 ¹³ / ₁₆ | 300 | | |
| | Length 2 | 9 ¹³ / ₁₆ | 250 | | |
| B* |  | Height | 5 ⁷ / ₈ | 150 | 5 units |
| | Depth | 9 ¹³ / ₁₆ | 250 | | |
| | Length 1 | 11 ¹³ / ₁₆ | 300 | | |
| | Length 2 | 11 ¹³ / ₁₆ | 300 | | |
| C |  | Height | 5 ⁷ / ₈ | 150 | 10 units |
| | Depth | 9 ¹³ / ₁₆ | 250 | | |
| | Length 1 | 14 ³ / ₄ | 375 | | |
| | Length 2 | 12 ¹³ / ₁₆ | 325 | | |
| D |  | Height | 5 ⁷ / ₈ | 150 | 10 units 5 right corners 5 left corners |
| | Depth | 9 ¹³ / ₁₆ | 250 | | |
| | Length 1 | 14 ³ / ₄ | 375 | | |
| | Length 2 | 13 ³ / ₄ | 350 | | |

Chestnut Brown



Sandlewood



Champlain Grey



Shale Grey





PILLAR 24" MINI-CRETA ARCHITECTURAL

DESCRIPTION: Pillar **TEXTURE:** Split face with straight edged corners

PALLET OVERVIEW

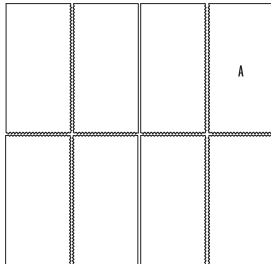

COMPATIBLE CAPS

See page 140 for product compatibility.

NOTES

See page 135 to 156 for more technical information.

| Specifications per pallet | | Imperial | Metric |
|---------------------------|----------------|----------------------|----------|
| PILLAR 24" x 3" | Cubing | 48 units | 48 units |
| | Approx. Weight | 1 537 lbs | 697 kg |
| | Number of rows | 6 | |
| | Pillar height | 35 $\frac{7}{16}$ in | 900 mm |

| Unit dimensions | | in | mm | Units/pallet |
|-----------------|--------|-------------------|-----|--------------|
| | Height | 2 $\frac{15}{16}$ | 75 | 48 units |
| | Depth | 8 | 203 | |
| | Length | 16 | 406 | |

| Specifications per pallet | | Imperial | Metric |
|---------------------------|----------------|----------------------|----------|
| PILLAR 24" x 6" | Cubing | 24 units | 24 units |
| | Approx. Weight | 1 510 lbs | 685 kg |
| | Number of rows | 3 | |
| | Pillar height | 35 $\frac{7}{16}$ in | 900 mm |

| Unit dimensions | | in | mm | Units/pallet |
|-----------------|--------|-----------------|-----|--------------|
| | Height | 5 $\frac{7}{8}$ | 150 | 24 units |
| | Depth | 8 | 203 | |
| | Length | 16 | 406 | |

Chestnut Brown



Sandlewood



Champlain Grey



Shale Grey



TECHO—BLOC

DESIGN CHART MINI-CRETA 6"

(EQUIVALENT TO TWICE THE MINI-CRETA 3")
SETBACK POSITION

CLEAN SAND/GRAVEL/ SAND AND GRAVEL MIXES ($\phi=34^\circ$, $\gamma = 120$ pcf)
GEOGRID: MIRAGRID 3XT BY TENCATE (RFd=1.10, RFcr=1.45, RFid=1.25, Cds=0.9, Ci=0.9)

CASE N° 1 :
No Surcharge
No Backslope
No Toe Slope

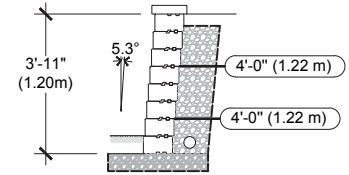
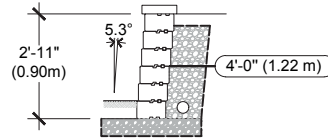
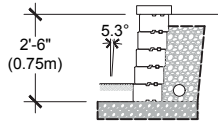

VISIT WWW.TECHO-BLOC.COM FOR COMPLETE DESIGN CHART DOCUMENT
(USA AND CANADA VERSIONS)

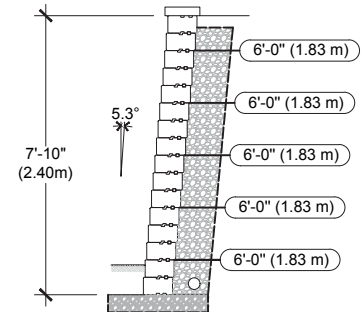
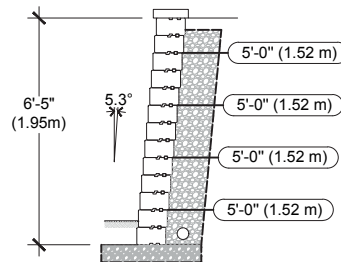
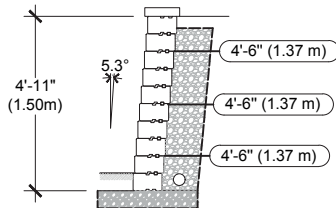

- The information contained in the design charts is supplied for information purposes only and as such should only be used for preliminary designs.
- The height (H) of the wall is the total height from the leveling pad to the top of the wall not including the thickness of the cap.
- Soil parameters: reinforced soil ($\phi = 34^\circ$, $\gamma = 120$ pcf); retained soil ($\phi = 34^\circ$, $\gamma = 120$ pcf); foundation soil ($\phi = 34^\circ$, $\gamma = 120$ pcf)
- A qualified engineer should be consulted for the final design to be used for construction.
- The foundation soil must be able to support the wall system. The bearing capacity of the foundation soil, settlement, and global stability must be verified and validated by a qualified geotechnical engineer.
- The seismic analysis is not included.
- The design charts do not apply to tiered walls.
- The charts assume that the walls are constructed in accordance with Techo-Bloc specifications, good construction practice and an adequate drainage system.
- The geogrid layout has been optimized to satisfy the design requirements of the NCMA's Design Manual for Segmental Retaining Walls, 3rd Edition.
- The minimum burial depth must be 6 in (150 mm) or 10% of the exposed height, whichever is greater.
- Engineering judgement should be used when interpolating between heights.
- Techo-Bloc and its predecessors, successors, beneficiaries, employees, associates, administrators and insurers accepts no liability for the incorrect use of information contained in the design charts.
- For further information, please contact our technical service department.

INSTALLATION GUIDE

RETAINING WALLS - MINI-CRETA 3" AND 6"

1-Row Pattern | Laying Patterns

The 1-row pattern provides five different combinations. Each combination is 8.9' (2.7 m) long and 5 7/8" (150 mm) high. **This pattern can be used to lay the last course of units or when the other models cannot be used.**

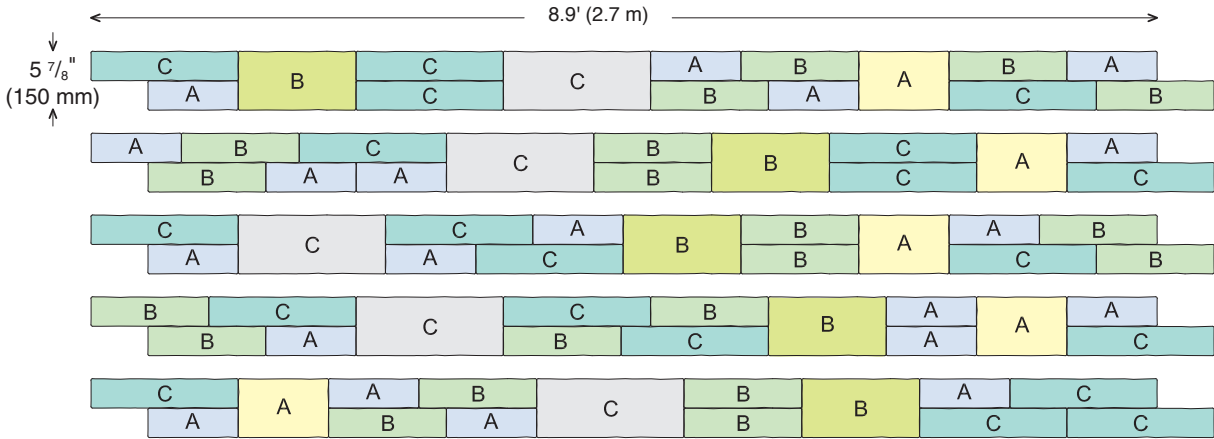

NUMBER OF BLOCKS REQUIRED

MODULE

MINI-CRETA

67% of the surface - Mini-Creta 3"

33% of the surface - Mini-Creta 6"

A

B OR B*

C OR D

4

4

4

1

1

1

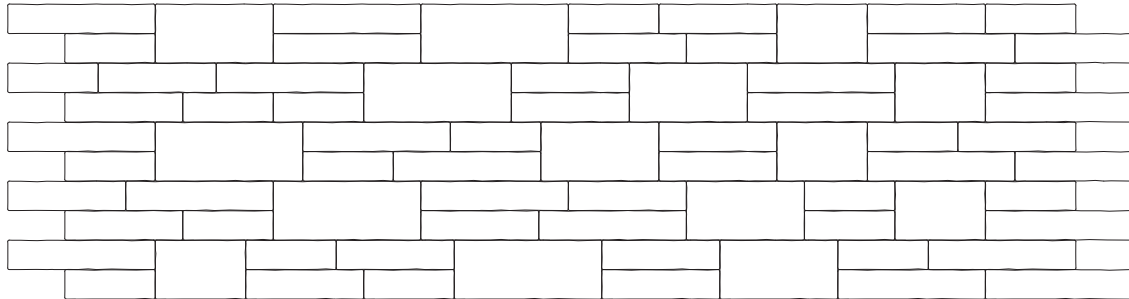

INSTALLATION GUIDE

RETAINING WALLS - MINI-CRETA 3" AND 6"

3-Row Pattern | Laying Patterns

The 3-row pattern provides four different combinations. Each combination is 8.9' (2.7 m) long and 17 1/16" (450 mm) high. This pattern gives a leveled surface every 17 1/16" (450 mm), which is the recommended spacing between two layers of geogrid in a Mini-Creta wall. **This pattern is recommended when using geogrid.**

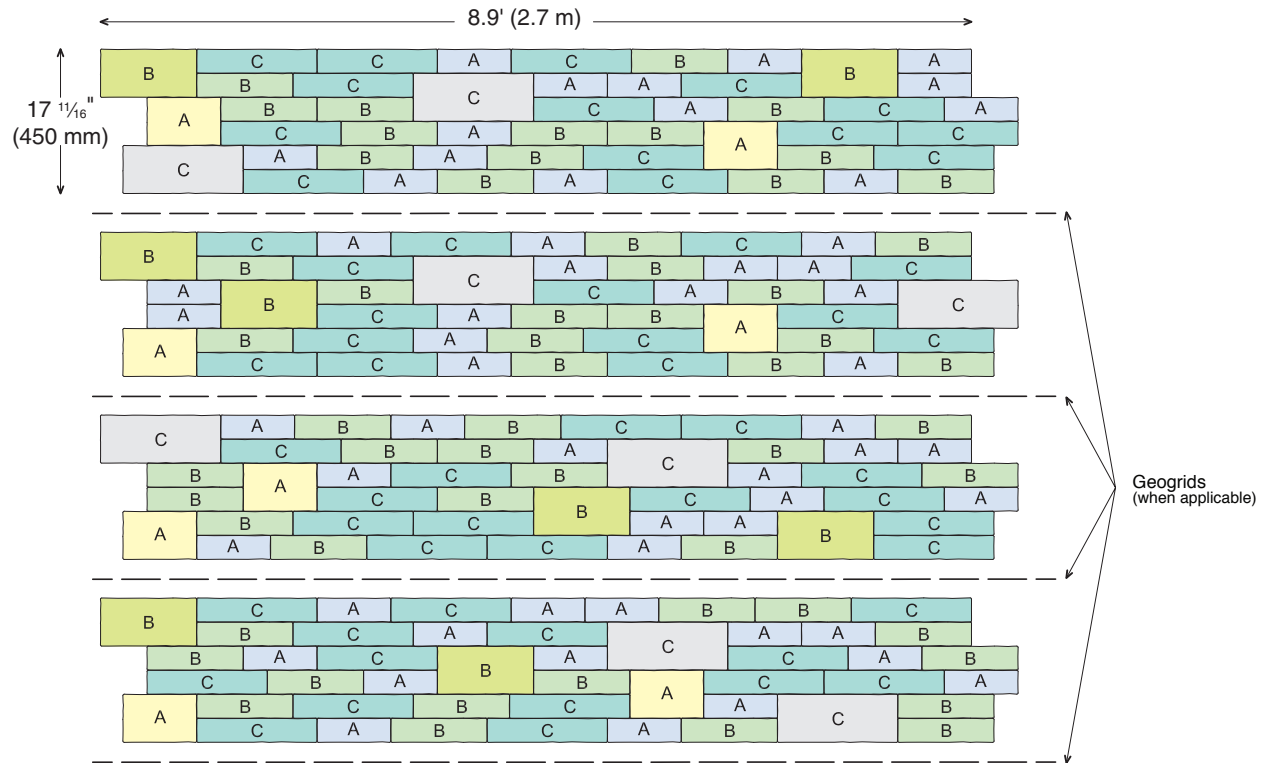

| NUMBER OF BLOCKS REQUIRED | MODULE | | |
|---|--------|---------|--------|
| | A | B OR B* | C OR D |
| 78% of the surface - Mini-Creta 3" | 14 | 14 | 14 |
| 22% of the surface - Mini-Creta 6" | 2 | 2 | 2 |

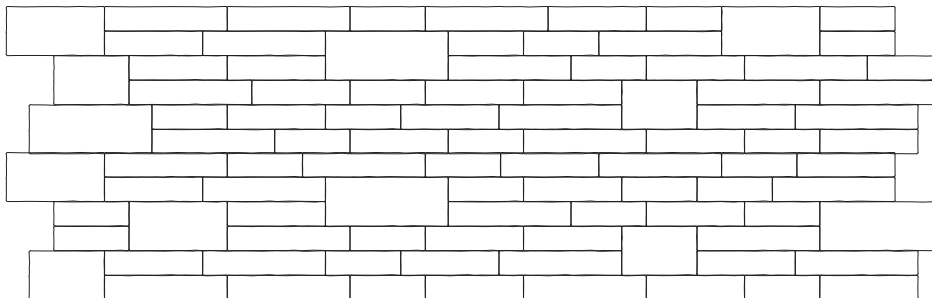

INSTALLATION GUIDE

RETAINING WALLS - MINI-CRETA 3" AND 6"

5-Row Pattern | Laying Patterns

The 5-row pattern provides three different combinations. Each combination is 8.9' (2.7 m) long and 29 1/2" (750 mm) high. **This pattern should only be used when geogrid is not required.**

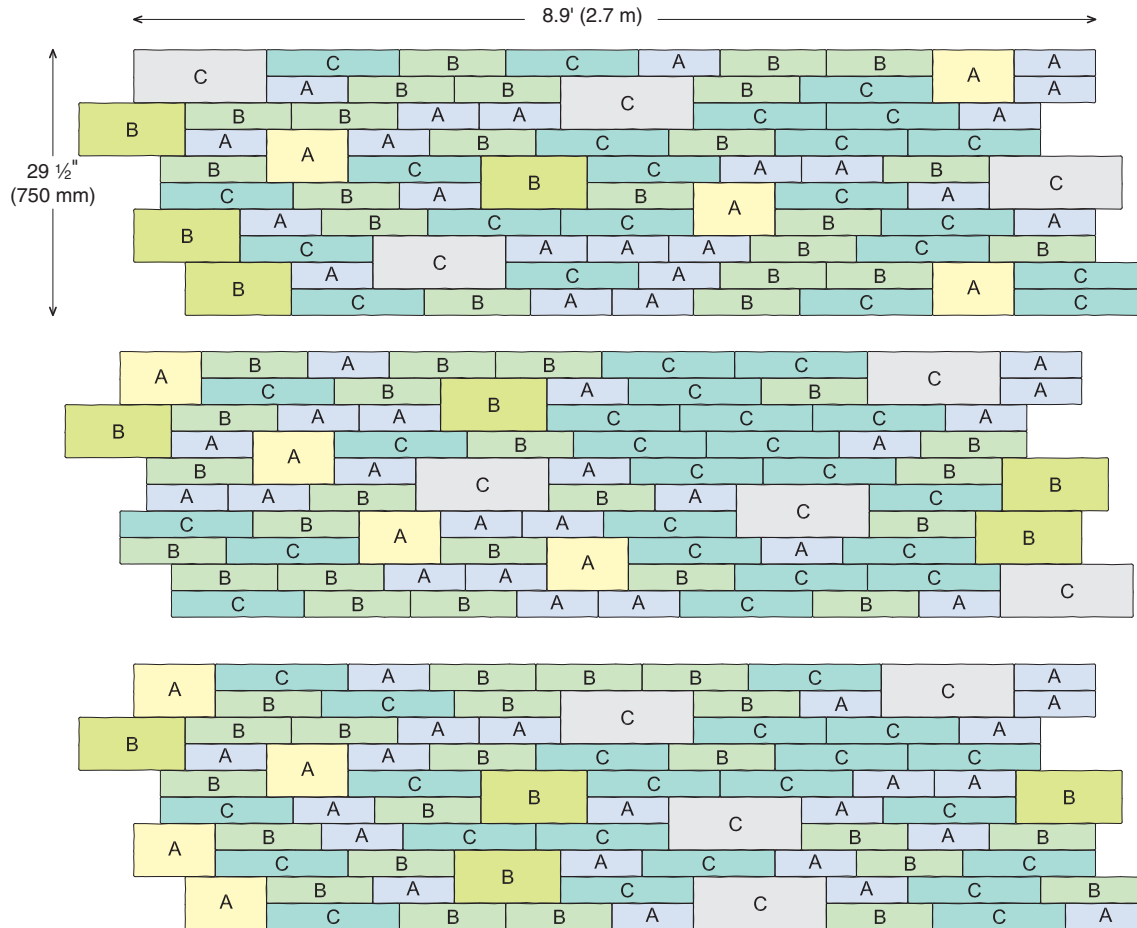

NUMBER OF BLOCKS REQUIRED

MODULE

MINI-CRETA

73% of the surface - Mini-Creta 3"

27% of the surface - Mini-Creta 6"

A

B OR B*

C OR D

22

22

22

4

4

4

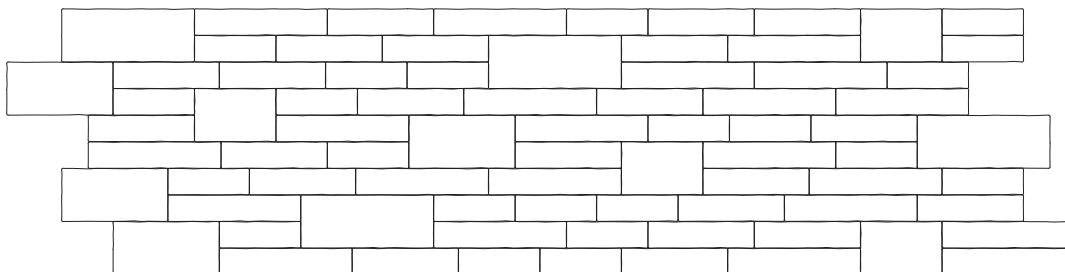

PLEASE REFER TO P.4 FOR THE CORRECT USE AND LIMITATIONS OF PROVIDED TECHNICAL INFORMATION.

INSTALLATION GUIDE

FREESTANDING WALLS - MINI-CRETA 3" AND 6"

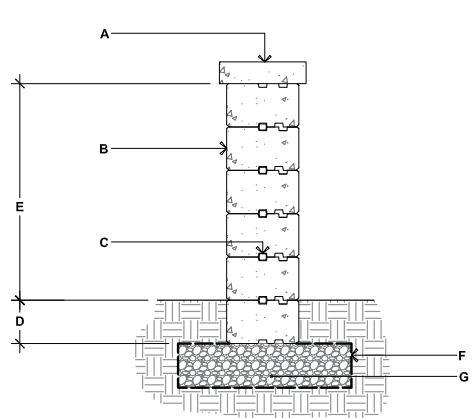

MINI-CRETA 3" & 6"

- A.** TECO-BLOC CAP UNIT SECURED TO UNIT BELOW WITH FLEXLOCK ADHESIVE
- B.** MINI-CRETA 3" AND 6" DOUBLE-SIDED WALL UNITS SECURE EACH ROW WITH FLEXLOCK ADHESIVE
- C.** CONNECTOR
- D.** EMBEDMENT DEPTH, 6" (150 mm) MIN.
- E.** 29 7/16" (750 mm) MAX.
- F.** GEOTEXTILE
- G.** COMPACTED GRANULAR LEVELING PAD, 6" (150 mm) THICK MIN. THICKNESS ACCORDING TO PROJECT SPECIFIC CONDITIONS

90° CORNER OF A DOUBLE-SIDED WALL

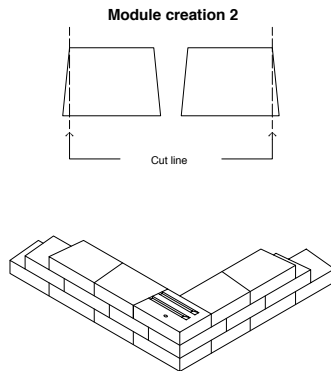
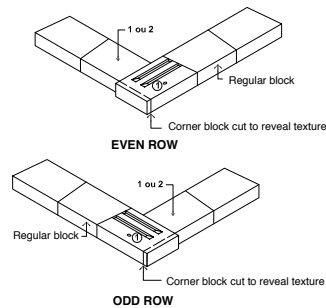

The corner block must be cut to reveal the texture

1. Alternate odd and even rows.
2. Stagger joints from one row to the next.
3. Glue all modules at each row with Flexlock adhesive.
4. Cavities, grooves and connectors are not illustrated to avoid overloading the image.
5. It is possible to alternate the blocks (A, B or C) in the same row to create different patterns. However, a corner block must always be present at the end of a row and must be alternated for each subsequent row.

DOUBLE-SIDED WALL - END OF A STRAIGHT WALL

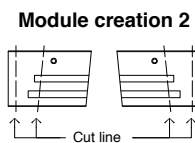
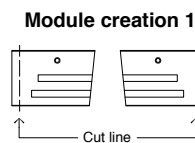
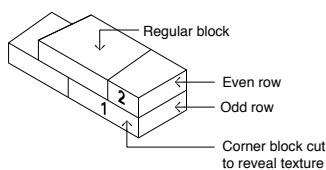

* It is possible to alternate the blocks (A, B or C) in the same row to create different patterns. However, a corner block must always be present at the end of a row and must be alternated for each subsequent row.

INSTALLATION GUIDE

DOUBLE-SIDED WALL RADIUS - MINI-CRETA 3" AND 6"

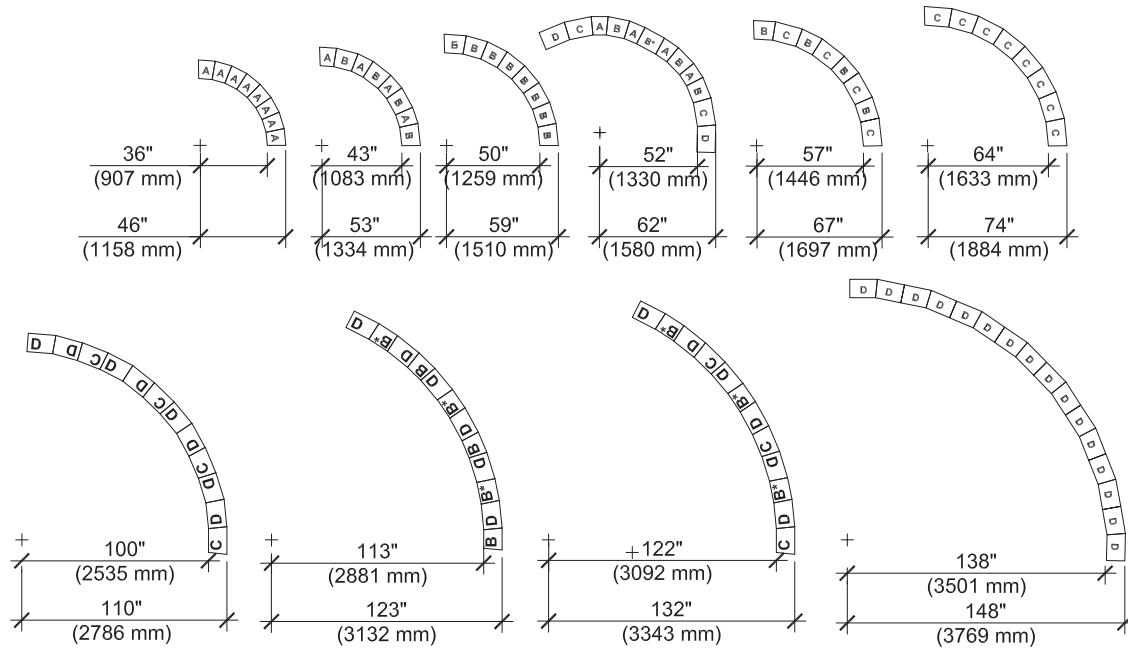

It is the user's responsibility to verify for the quantity of materials required.

STEPS

MINI-CRETA 3"

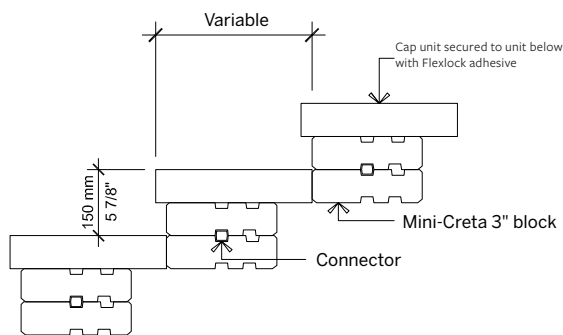

MINI-CRETA 6"

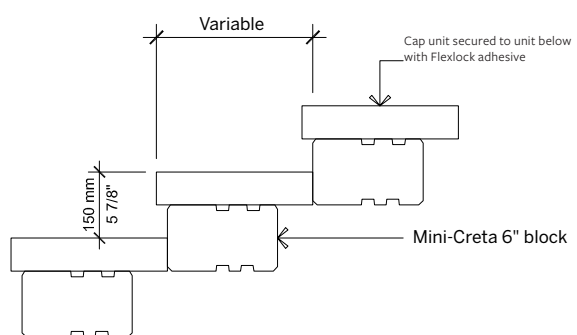

For all possible combinations of pillars and caps, please refer to the correspondence table on page 140

INSTALLATION GUIDE

PILLARS- MINI-CRETA 3" AND 6"

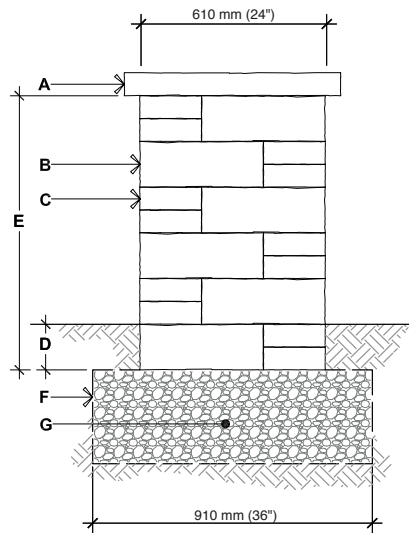

PILLAR 24" x 3" & 24" x 6"
MINI-CRETA - OPTION A

- A.** PILLAR CAP UNIT
(SECURE WITH FLEXLOCK ADHESIVE)
- B.** PILLAR 24" x 6" (MINI-CRETA) UNIT
SECURE EACH ROW WITH FLEXLOCK ADHESIVE
- C.** PILLAR 24" x 3" (MINI-CRETA) UNIT
SECURE EACH ROW WITH FLEXLOCK ADHESIVE
- D.** EMBEDMENT 6" (150 mm) MIN.
- E.** 35 ⁷/₁₆" (900 mm)
47 ¹/₄" (1200 mm), MAXIMUM HEIGHT
- F.** GEOTEXTILE
- G.** COMPACTED GRANULAR BASE 150 mm (6")
THICK MIN. THICKNESS ACCORDING TO
PROJECT SPECIFIC CONDITIONS

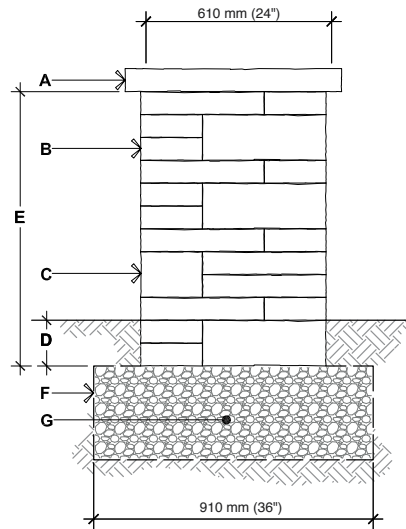

PILLAR 24" x 3" & 24" x 6"
MINI-CRETA - OPTION B

- A.** PILLAR CAP UNIT
(SECURE WITH FLEXLOCK ADHESIVE)
- B.** PILLAR 24" x 3" (MINI-CRETA) UNIT
SECURE EACH ROW WITH FLEXLOCK ADHESIVE
- C.** PILLAR 24" x 6" (MINI-CRETA) UNIT
SECURE EACH ROW WITH FLEXLOCK ADHESIVE
- D.** EMBEDMENT 6" (150 mm) MIN.
- E.** 35 ⁷/₁₆" (900 mm)
47 ¹/₄" (1200 mm), MAXIMUM HEIGHT
- F.** GEOTEXTILE
- G.** COMPACTED GRANULAR BASE 150 mm (6")
THICK MIN. THICKNESS ACCORDING TO
PROJECT SPECIFIC CONDITIONS

For all possible combinations of pillars and caps, please refer to the correspondence table on page 140

PLEASE REFER TO P.4 FOR THE CORRECT USE AND LIMITATIONS OF PROVIDED TECHNICAL INFORMATION.

INSTALLATION GUIDE

PILLARS- MINI-CRETA 3" AND 6"

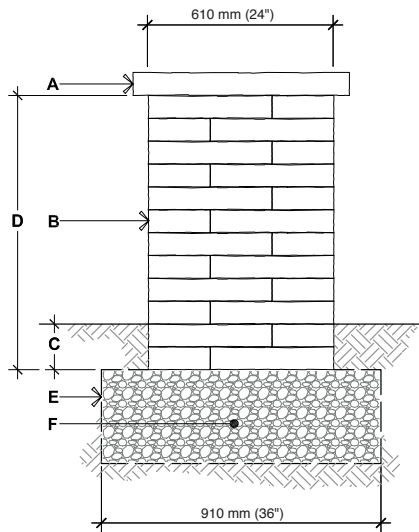

PILLAR 24"×3"

MINI-CRETA

- A. PILLAR CAP UNIT
(SECURE WITH FLEXLOCK ADHESIVE)
- B. PILLAR 24" × 3" (MINI-CRETA) UNIT SECURE
EACH ROW WITH FLEXLOCK ADHESIVE
- C. EMBEDMENT 6" (150 mm) MIN.
- D. 35 ⁷/₁₆" (900 mm), HEIGHT PER PALLET
47 ¹/₄" (1200 mm), MAXIMUM HEIGHT
- E. GEOTEXTILE
- F. COMPACTED GRANULAR BASE 150 mm (6")
THICK MIN. THICKNESS ACCORDING TO
PROJECT SPECIFIC CONDITIONS

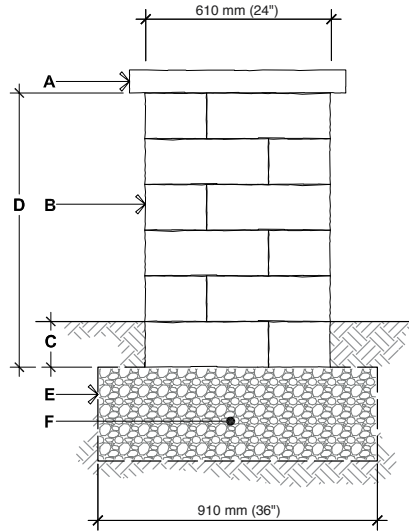

PILLAR 24"×6"

MINI-CRETA

- A. PILLAR CAP UNIT
(SECURE WITH FLEXLOCK ADHESIVE)
- B. PILLAR 24" × 6" (MINI-CRETA) UNIT
SECURE EACH ROW WITH FLEXLOCK ADHESIVE
- C. EMBEDMENT 6" (150 mm) MIN.
- D. 35 ⁷/₁₆" (900 mm), HEIGHT PER PALLET
47 ¹/₄" (1200 mm), MAXIMUM HEIGHT
- E. GEOTEXTILE
- F. COMPACTED GRANULAR BASE 150 mm (6")
THICK MIN. THICKNESS ACCORDING TO
PROJECT SPECIFIC CONDITIONS

For all possible combinations of pillars and caps, please refer to the correspondence table on page 140

INSTALLATION GUIDE

GRILL ISLAND 6 FT - MINI-CRETA 3" AND 6"

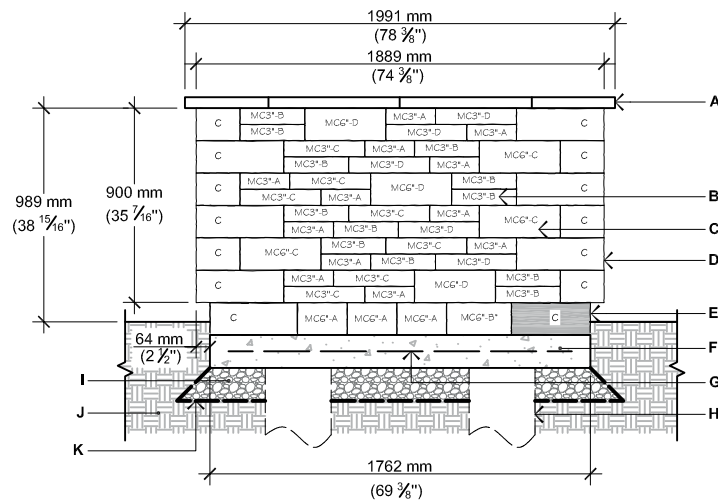
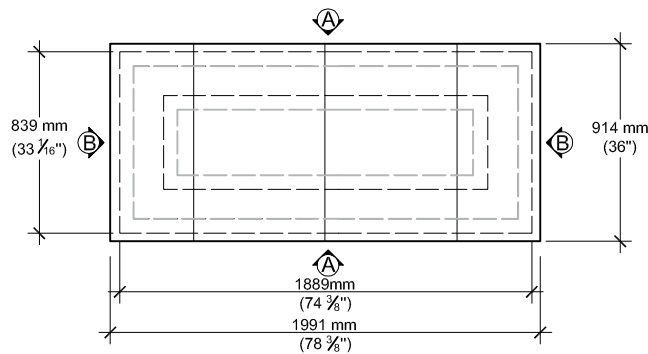

ELEVATION A

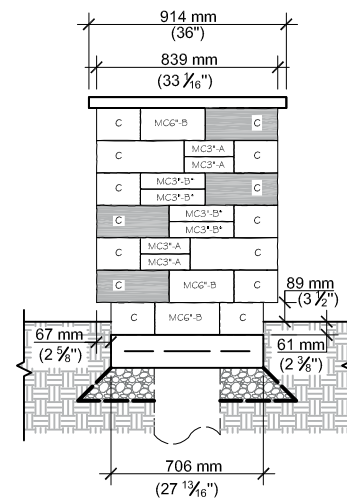

ELEVATION B

- A. YORK COUNTER TOP 24" × 36" × 2 1/4"
- B. MINI-CRETA 3" UNIT (A, B, B*, C, OR D)
- C. MINI-CRETA 6" UNIT (A, B, B*, C, OR D)
- D. PILLAR 24" × 36" (MINI-CRETA) UNIT
- E. PILLAR 24" × 36" (MINI-CRETA) UNIT (CUT ON FIELD)
- F. CAST IN PLACE CONCRETE SLAB 4350 psi (30 MPa), 5" (125 mm) THICK
- G. 4X4-4/4 (102X102-MW25.8XMW25.8) WELDED WIRE MESH AND/OR REBAR AS PER SITE CONDITIONS
- H. 12" (300 mm) DIA. CONCRETE PILLAR, AS PER LOCAL CODE
- I. 3/4" (20 mm) CLEAN STONE
- J. 6" (150 mm) THICK MIN. AS PER SITE CONDITIONS
- K. NATURAL SOIL OR COMPACTED BACKFILL
- K. GEOTEXTILE

QUANTITY OF MATERIALS REQUIRED

- York Counter top 24" × 36" × 2 1/4": **4**
- Mini-Creta 3" unit: **32 A, 24 B, 8 B*, 14 C, 10 D**
- Mini-Creta 6" unit: **6 A, 6 B, 2 B*, 6 C, 6 D**
- Pillar 24" × 6" (Mini-Creta) unit: **28**

NOTE: Appliances and utilities may vary for each project and are not shown on this drawing. This drawing is shown for inspiration only and surplus or shortage of materials may result. It is the user's responsibility to verify for the quantity of materials required. Secure the blocks using a heat resistant concrete adhesive. The installer must ensure that the installation and use of the grill island comply with local regulations and code requirements. Concrete pillars extending to frost line may be required as per local code. Check your local building code before installing.

INSTALLATION GUIDE

SQUARE FIRE PIT - MINI-CRETA 3" AND 6"

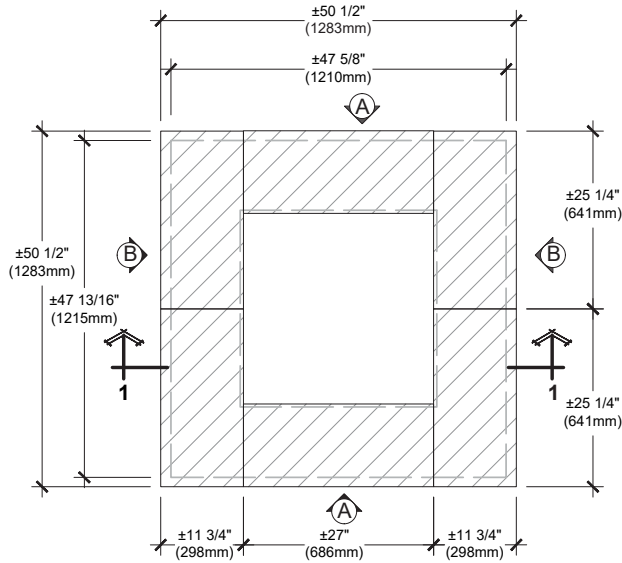

TOP

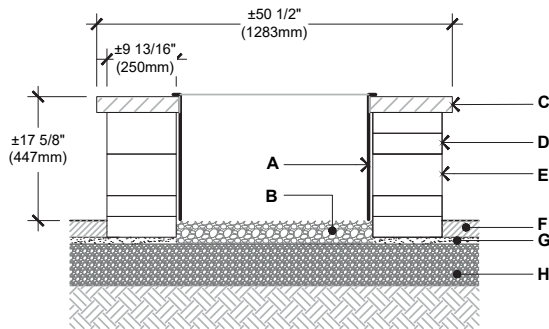

SECTION 1-1

- A. STEEL BOX INSERT
- B. CLEAN CTONE 3/4" (20 mm), 4" (100 mm) THICK
- C. PIEDIMONTE CAP (12"X30")
- D. MINI-CRETA 3" BLOCK
- E. MINI-CRETA 6" BLOCK
- F. TECO-BLOC PAVERS OR SLABS
- G. SETTING BED 1" (25 mm)
- H. COMPACTED GRANULAR 0- 3/4" (0-20 mm)
- I. PILLAR 24"X6" MINI-CRETA

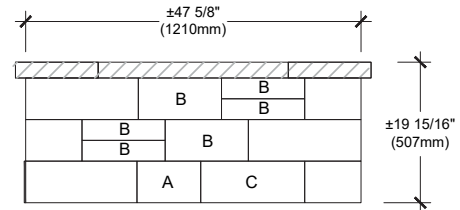

ELEVATION A

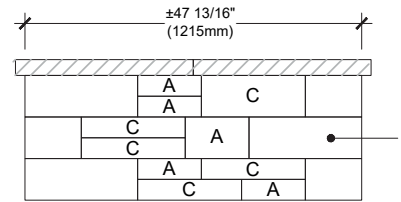

ELEVATION B

CUT ON FIELD

QUANTITY OF MATERIALS REQUIRED

- Piedimonte Cap (12"x30") = 6
- Mini-Creta 3" (A) = 8
- Mini-Creta 3" (B or B*) = 8
- Mini-Creta 3" (C or D) = 8
- Mini-Creta 6" (A) = 4
- Mini-Creta 6" (B or B*) = 4
- Mini-Creta 6" (C or D) = 4
- Pillar 24"x6" Mini-Creta= 12

NOTE: Secure the blocks using a heat resistant concrete adhesive. The installer must ensure that the installation and use of the firepit comply with local regulations and code requirements.