

The enduring strength, beauty and performance of a brick wall assembly is critically dependant on three components: design, workmanship and materials. If even one of these factors has not been diligently applied, integrity of the wall assembly is compromised.

The single most important factor to be understood and designed for in the severe northern climate is moisture control. Seldom does failure of a brick wall assembly occur without the presence of an excessive moisture load. Excessive is defined as being more moisture than can dry out of the assembly before that assembly freezes due to ambient temperature conditions. The trapped moisture will freeze and thaw and may cause deterioration known as spalling, in which part of the brick surface may break away.

This Technical Note is applicable to those areas subjected to severe winter weather, including Canada and the northern states of the USA.

Examples of Extra Severe Weathering Conditions:

- Houses and buildings built within the spray zone of lakes
- Buildings constructed in open areas with little or no protection from the wind by other buildings or trees
- Upper floors of high rise buildings

It should be noted that certain parts of masonry structures are more vulnerable to the weather than others. These include parapet walls surmounting multi-storey buildings, freestanding walls, chimneys and walls put in contact with the grade level. In these adverse conditions, it is even more critical to ensure the correct use of materials, details and workmanship.

Chimneys

The two most critical components of chimney construction are workmanship and a proper chimney cap. (See Fig. A for proper chimney cap details.)

Ensure that the chimney cap installed has an overhang of no less than 50mm, and a drip groove (as shown in Fig. A) to shed water past the plane of the four chimney walls. Ensure that all joints are properly caulked.

Note: The through wall flashing detail shown in Fig. A applies to all masonry walls which traverse the roof line. i.e. where an exterior wall (or chimney) above the roofline is supported below the roofline by masonry, through wall flashing must be installed at the roofline to direct water to the exterior.

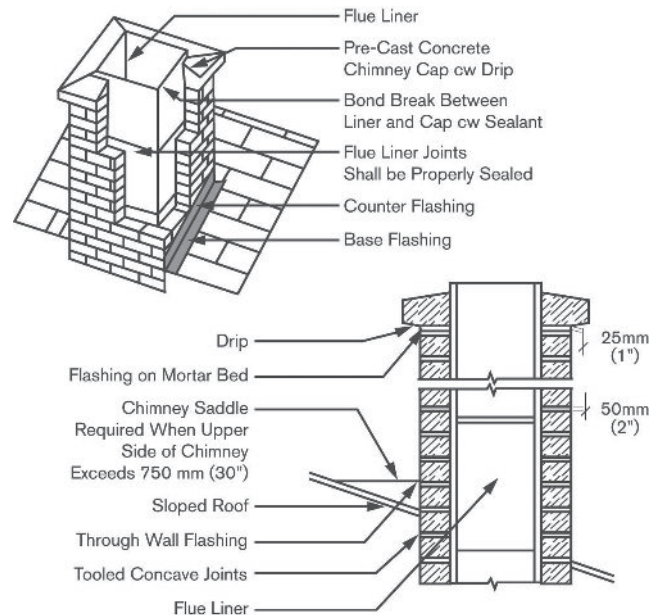

Fig. A Chimney Cap Construction Details

Window Sills

Window sills are subjected to copious water run off from the glazing above. Unlike brickwork which will absorb most of the precipitation which reaches the wall, glazing is impervious and will shed all precipitation, resulting in large accumulation of moisture at the sill. This accumulation is even greater for bay windows and atrium type windows, which have a horizontal component of glazing.

It is critical that the sill be correctly designed to help shed this water away from the masonry below and avoid excess accumulation of moisture in the brickwork.

Important details for window sills include:

- Minimize the number of joints
- Ensure minimum slope of 15° to sill
- Provide drip groove
- Provide adequate flashing including end dams
- Caulk all joints

The most fail-safe detail is to choose a stone, precast concrete or metal sill that is tailored to the window opening and has a slope on top and a drip groove/lip on the under side. (See fig. B and C)

Sill pan flashing is also recommended to allow for any leakage through the window frame.

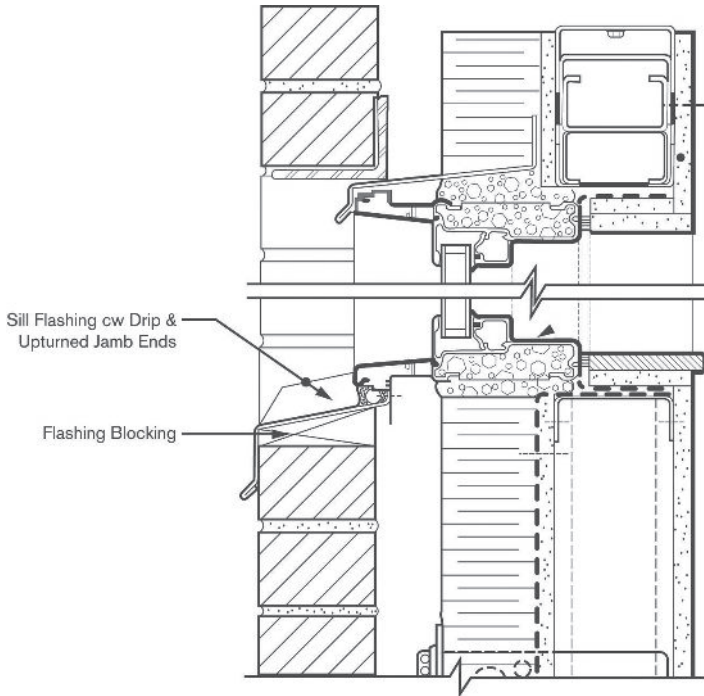

Fig. B Metal Window Sill Detail

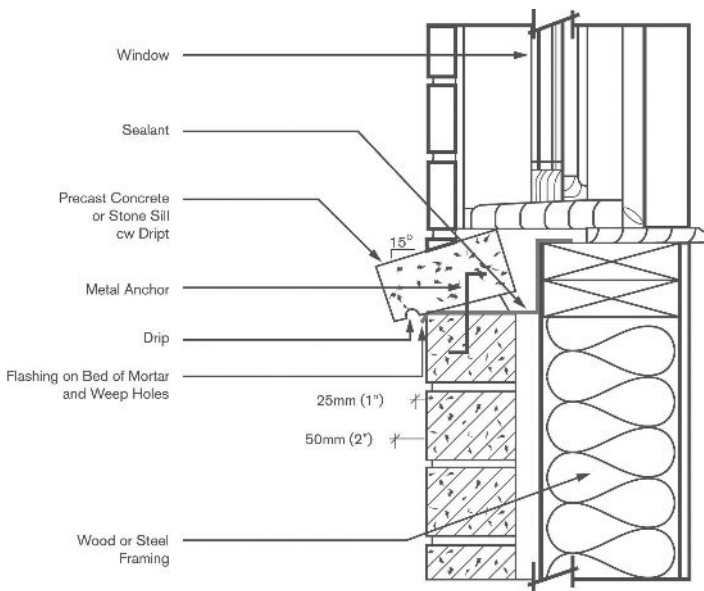

Fig. C Stone Window Sill Detail

Brick at Grade

Brick built on grade can result in the ingress of moisture, either from direct water run-off or the build-up of snow. Excess moisture present in the brick during the freeze-thaw cycles can result in spalling of the brick.

Good building practice dictates that brickwork should be a minimum of 150mm above grade.

This requirement also applies to any level surface such as paving, patio deck or balcony. Furthermore, the ground should be contoured so that the water drains away from the wall. (See Fig. D)

Base wall flashing should be installed below the bottom course of masonry to prevent the upward migration of moisture due to capillary action (rising damp).

Always slope the grade away from the building. The masonry wall assembly should begin no less than 150mm above the grade line.

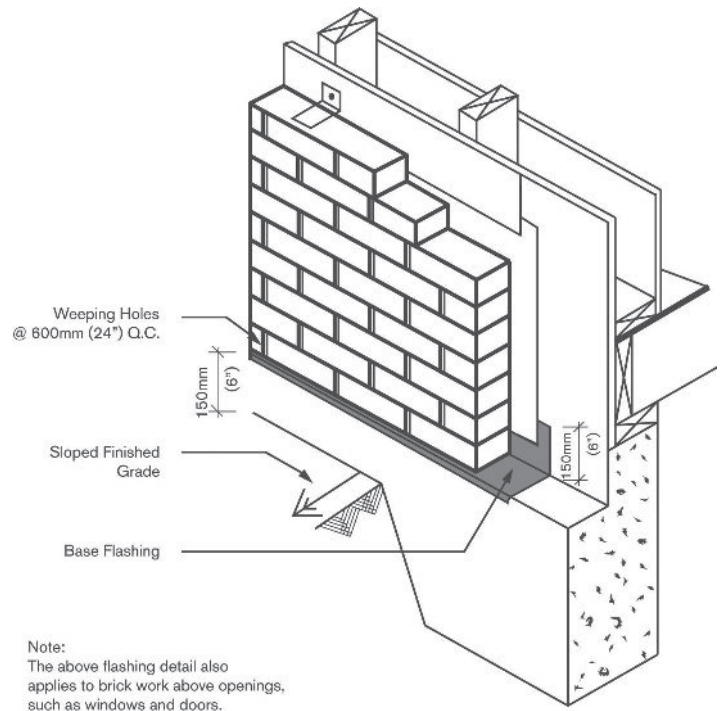

Note:
 The above flashing detail also applies to brick work above openings, such as windows and doors.

Fig. D Brick at Grade Detail

Grade should be measured from the top of the finished surface. This means that grade should be considered to be the top of a wooden deck, a stair tread, a poured concrete balcony, or any sort of finished surface, be it paving brick, gravel, asphalt, or the earth in a planting bed.

Weepholes - Brick Veneer Walls

Brick veneer walls, if correctly installed, provide the best protection from rain penetration. However, often critical details are omitted, causing the wall to become ineffective and water to penetrate past the wall. Two of the details often omitted are weepholes and flashing. (See Fig. D)

This detail should be at the base of all brick veneer walls, on top of windows, doors and other openings into brick veneer walls.

Parapet Walls and Columns

The top of parapet walls, freestanding walls and columns are subjected to the same severe weathering as chimneys. Hence, they also require special attention to details. Figure E and F shows a typical cap for a wall or column. A stone, metal, or precast concrete cap with an overhang and drip groove is recommended.

The minimum overhang for stone and precast concrete copings should be 50mm with the placement of the drip groove 25mm from the masonry wall.

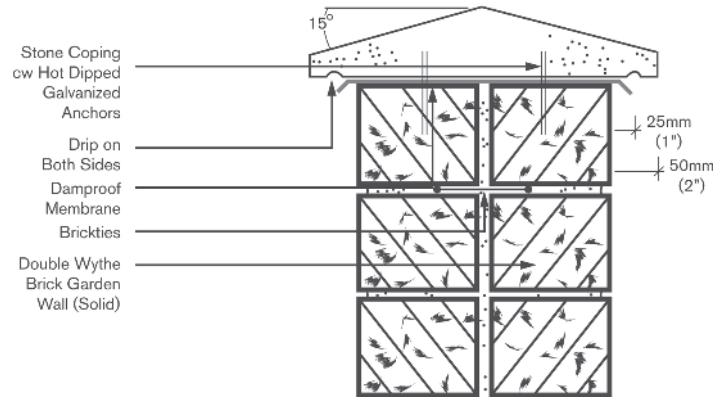
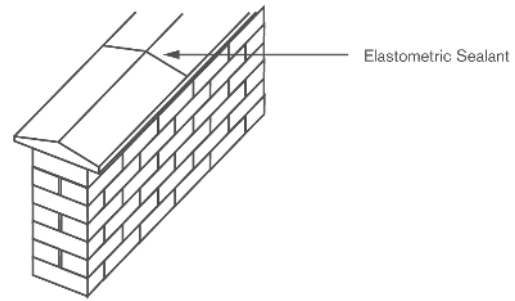

Fig. F Coping to Freestanding Walls

Retaining Walls, etc...

Brick walls used to retain soil, in planters, or other applications will be subjected to moisture ingress from the soil. The brick wall should be constructed with a concrete block backup wall with a cavity (airspace), base flashing and weepholes to permit moisture to drain away from the masonry.

The interior side of the concrete block backup should be coated with a waterproof material to prevent moisture transmission through the wall. (See Fig. G)

Drainage should be provided at the base of the planter box to prevent the build up of hydrostatic pressure.

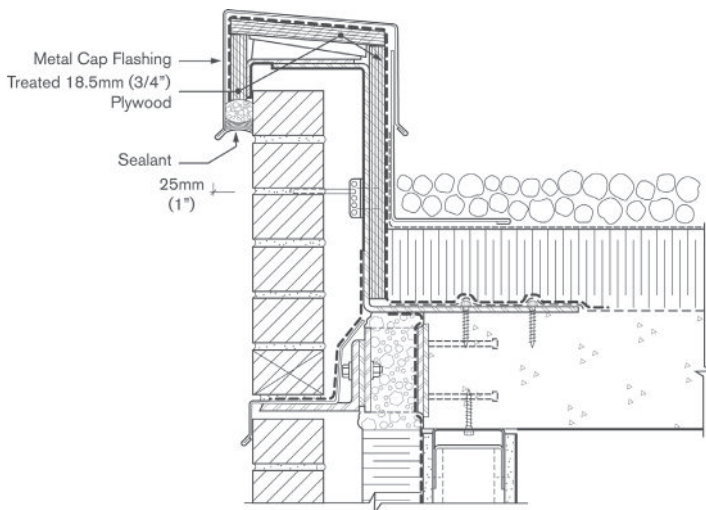

Fig. E Parapet Cap Detail

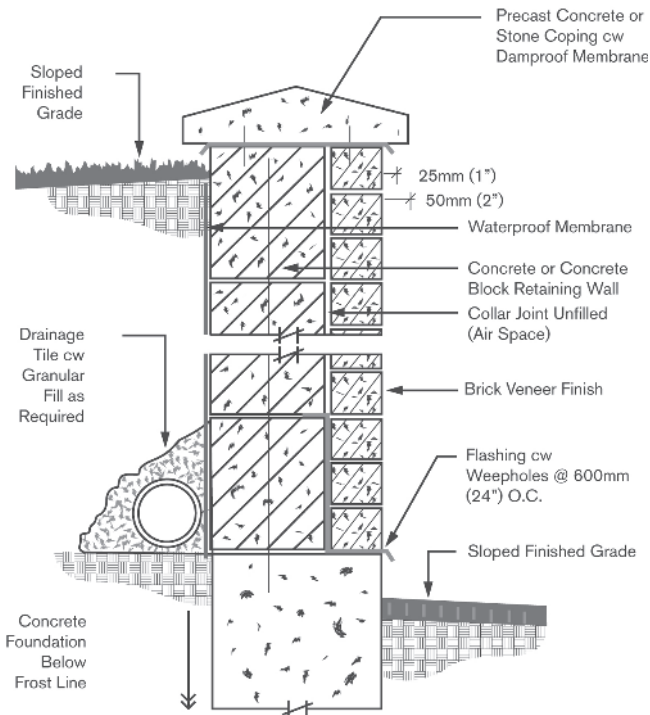

Fig. G Planter and Retaining Walls

Roofing Details - Overhang

Buildings should be designed with adequate roof overhang to reduce the exposure of the wall to weathering. (See Fig. H)

Research shows that even a modest roof overhang significantly reduces the amount of water reaching the wall. Eaves troughs (gutters) and downpipes should be correctly sized and positioned to remove rainwater without undue overflow onto the walls.

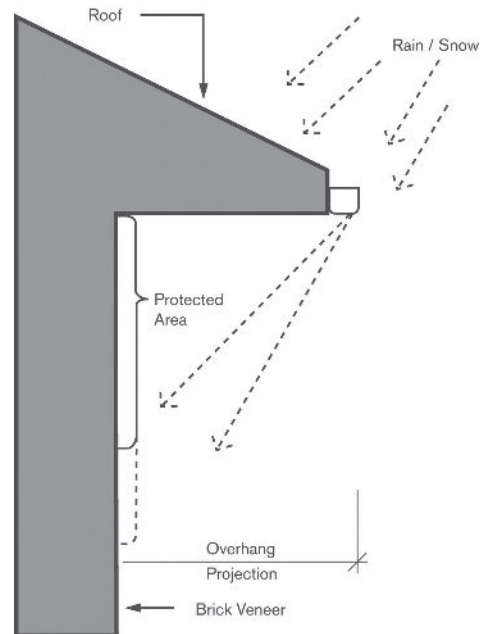

Fig. H Effect of Roof Overhang

Caulking and Sealants

Caulking of joints is critical to prevent the ingress of moisture. However, with time and weathering, elastomeric caulking materials will deteriorate and become ineffective. Caulking materials should be inspected regularly and replaced when necessary.

Water Repellent & Colorless Coatings

The Brick Institute of America (BIA) warns that in climates that experience freeze-thaw cycling, colorless coatings may adversely affect the durability of brick masonry by inhibiting moisture evaporation. The use of breathable masonry water repellents is suggested sometimes as a possible solution to leaky walls. Before these products are considered, construction details need to be checked for integrity. Items contributing to leakage include ineffective flashing at the base of the wall, absence of a clear cavity and weepholes, unfilled head joints or cracks at the mortar/brick interface. Air leakage from the interior can be a major cause of moisture on the inside of the brick veneer.

Gas Furnace Outlet

The vents from gas furnaces and other appliances should be directed to discharge moisture laden air away from the masonry.

Workmanship

Beside the use of correct materials and proper design details, good workmanship is required to ensure successful performance of masonry.

Joint Profiles

The tooling and profile of a mortar joint has a significant effect on the ability of the masonry to resist moisture penetration. Different joint profiles are shown in Fig. 1.

Raked joints are popular because they accentuate the aesthetics of the brick. However, they are not recommended for exterior masonry work in the severe northern climate. Raked joints provide a ledge for moisture ingress and retention.







Concave tooled joints are recommended for all exterior masonry. Joints should be tooled when the mortar is thumbprint hard. The jointing tool should be larger than the joint width; i.e. use a 12mm diameter tool for a 10mm joint width. The tooling process smooths and compresses the joint to promote superior water repellency.

Summary

If moisture entry and retention in the brickwork is avoided by the application of well considered design, quality workmanship and the correct choice of component materials, the enduring strength, beauty and performance of your masonry wall assembly should always be a source of pride.

Please consider the information listed in these technical notes as advisory highlights only. There are certainly many more conditions to be considered in the design and construction of a masonry wall assembly in a severe weather climate zone such as the northern region.

Those considerations are best left to the design and construction professionals.

Profile		Rain Resistance
Concave*		Good
V-Shape		Fair
Weathered		Fair
Flush		Poor
Struck		Very Poor
Raked		Very Poor

*Preferred Profile

Fig. 1 Mortar Joint Profile